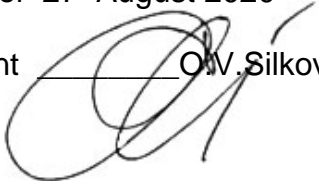

It is approved  
on meeting of department of  
medical informatics, medical and biological physics  
27 August 2020  
Minutes №1 of 27 August 2020

Head of department  O.V. Silkova

### Methodical instructions

for students' self-preparation work at preparation for a practical lesson  
at home and at the classroom

Subject matter            **Medical and biological physics**  
The unit                    2. Bases of medical physics  
Theme of lecture:        **Electrodynamics bases. Analysis of work of Wheatstone  
bridge (electric balance).**  
Year                         1  
Faculty                     Medical  
Speciality                 Medicine

Poltava – 2020

#### The topic significance:

The measurement of electrical resistance is the widely widespread procedure in engineering and scientific researches, including biophysics. The methods of measurement of resistance, which are used in the given time, are very various, but one of most widespread and exact is the method of Wheatstone bridge (electric balance). Electric balances are used for measurement of impedance and capacitance too.

#### Specific targets:

- To have general knowledge of the topic studied;
- To understand, to remember and to use the knowledge received;
- To form the professional experience by reviewing, training and authorizing it;
- To be able to carry out laboratory and experimental work.

#### Basic knowledge, experience, skills necessary for studying the topic in connection with other subjects:

Disciplines	Obtainable skills
Previous (providing disciplines): physics, mathematics, chemistry, biology	To know concepts: electric field, potential, potential difference, gradient. Ohm's law, electrolytic dissociation, diffusion potential (electrochemical potential) To describe them. To describe electrokinetic appearances, membrane's pumps work, membrane's permeability
Subsequent disciplines: Normal physiology	To know role of electric processes in cell, tissues and whole organism functioning.

**Materials for the before-class self-preparation work:**

List of main term, parameters, characteristics, which student have to learn at preparation to class:

Term	Definition
Bridge	Measuring devices for measurement of impedance, resistance, capacitance and inductance also. Use balancing of currents in electric circuit.
Impedance	Integral electrical resistance of objects.
Dispersion of impedance	Graduated changes of impedance on change of alternating electric field frequency
Polarisation	Charges in substance have an opportunity to move from one electrode to another under activity of electric field in restricted volumes, forming inner electric field opposite in relation to the outer electric field calling polarisation.
Relaxation time	Time of originating of dipole polarization.
Bias current	Current of bound charges under activity of a field have an opportunity to move, forming a current of conduction, limited in time.

**Theoretical questions to class:**

1. Ohm's law.
2. Bridges theory.
3. The Wheatstone bridge.
4. Impedance.
5. Electrical properties of biological tissues.
6. Polarisation in electrostatic field.
7. Alternating current in biological tissues.

**Practice work executed at class:**

**Determination of resistances using the Wheatstone bridge.**

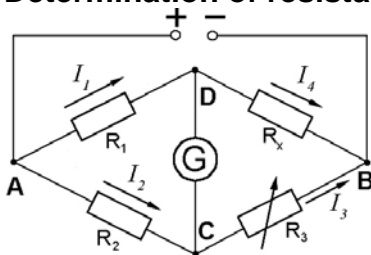

**The circuit diagram of the Wheatstone bridge for resistance measurement.**

Measure of unknown resistance with Wheatstone bridge help:

- to assemble the bridge according to circuit;
- attach  $R'$  into bridge in position  $R_x$ ;
- to balance the bridge (galvanometer  $G$  reads zero);
- at balance of the bridge  $R_x=R_3$ .

Write  $R'$  value into table.

Remove  $R'$  and attach  $R''$  into bridge in position  $R_x$ ;

Repeat measurements and write  $R''$  value into table.

Measure of resistances combinations with Wheatstone bridge help

Repeat these operations with series connection of  $R'$  and  $R''$  in position  $R_x$ ;

Repeat these operations with parallel connection of  $R'$  and  $R''$  in position  $R_x$ ;

Calculation of resistances combinations.

Calculate values  $R_{series}$  at series connection of  $R'$  and  $R''$  and  $R_{parallel}$  at parallel connection of  $R'$  and  $R''$  and compare with measured value.

Write results of calculations into a table.

**Result table.**

Resistance	Measurement	Calculation
$R'$ , Ohm		–
$R''$ , Ohm		–
$R_{series}$ , Ohm		
$R_{parallel}$ , Ohm		

To draw the conclusion.

### Contents of the topic.

Bridges are among the most accurate types of measuring devices used in the measurement of impedance. Bridges are used for precision measurements of resistance, capacitance and inductance also.

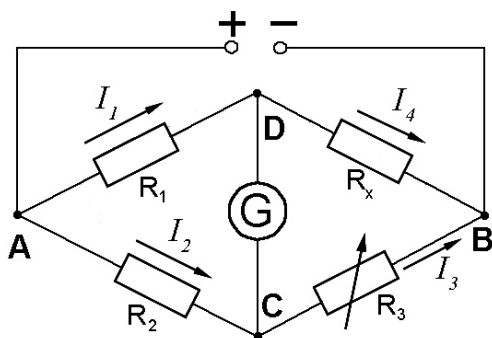

Fig.1. The circuit diagram of the Wheatstone bridge for resistance measurement.

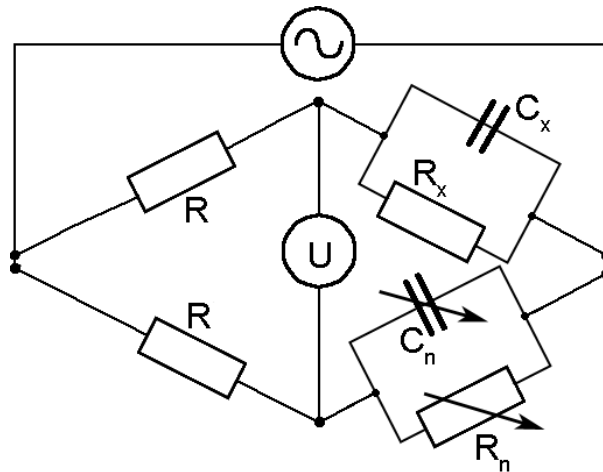

Fig.2. The circuit diagram of the Wheatstone bridge for impedance measurement.

Resistors  $R_1$  and  $R_2$  are precision and constant resistors,  $R_3$  is variable resistor (or resistor bank). Resistor bank is set of resistors, that can be arranged for reaching of any value between lead terminals of bank. The value of  $R_x$  is an unknown; it is resistance that must be determined. The galvanometer (an instrument that measures small amounts of current) is inserted across terminals  $C$  and  $D$  to indicate the condition of balance. When the bridge has been balanced perfectly, no difference in potential exists across terminals  $C$  and  $D$ , the galvanometer  $G$  reads zero. In this case the unknown resistance value is equal to  $R_3$ .

When the battery on, electron stream flows from the negative terminal of the battery to point  $A$ . It corresponds to the current direction from  $+$  to  $-$ . In point  $A$  the current divides between two parallel circuit. Part of it passes through  $R_1$  and  $R_2$ , other passes through  $R_x$

and  $R_3$ . The two currents  $I_1$  and  $I_2$  unite at point  $B$  and return to the positive terminal of the battery.

According to Ohm's law, the current is inversely proportional to the resistance. In case of breakage between points  $C$  and  $D$  the value of  $I_2$  depends on the sum of resistance  $R_2$  and  $R_3$ , and the value of  $I_1$  depends on the sum of resistances  $R_1$  and  $R_x$ .

At presence of galvanometer  $G$  if  $R_x \neq R_3$ , currents  $I_3$  and  $I_4$  are not equal, current flows through galvanometers  $G$ . If  $R_1 = R_2$  and  $R_x = R_3$ , currents  $I_3$  and  $I_4$  are equal, no current flows through galvanometers  $G$ .

If resistors  $R_1$ ,  $R_2$ , and  $R_3$  are different, when no current through galvanometers  $G$ , next expression is valid:  $R_x = \frac{R_1 \cdot R_3}{R_2}$ .

When examined object has resistive and capacitor properties, used balance scheme corresponding to scheme represented on fig.2.

The Wheatstone bridge illustrates the concept of a difference measurement, which can be extremely accurate. Variations on the Wheatstone bridge can be used to measure capacitance, inductance, impedance and other quantities, such as the amount of combustible gases in a sample, with an explosimeter. The **Kelvin bridge** was specially adapted from the Wheatstone bridge for measuring very low resistances. In many cases, the significance of measuring the unknown resistance is related to measuring the impact of some physical phenomenon – such as force, temperature, pressure, etc. – which thereby allows the use of Wheatstone bridge in measuring those elements indirectly.

The Wheatstone bridge is the fundamental bridge, but there are other modifications that can be made to measure various kinds of resistances when the fundamental Wheatstone bridge is not suitable.

### **Electrical measurements in biology and medicine.**

#### **Electric conductivity of cells and tissues**

Passive electrical properties are inherent in biological objects: resistance and capacity (condensance). Studying of passive electrical properties of biological objects is of great importance for comprehension of frame and the physicochemical state of biological substance.

Biological objects have properties as conductors, and dielectrics. Presence of free (loose) ions in cells and tissues causes conduction of these objects.

In the circuits keeping capacitors or inductances, resistance to alternating current depends on frequency of current, there introduces concept of an impedance - efficient resistance to alternating current.

At current passage through a living tissue it experimentally established, that this circuit has properties both the active resistance, and capacity. It is proved by a calorification and decrease of the complete resistance of a tissue with ascending frequency.

Properties of inductance practically it is not found out in a living tissue. Thus, the living tissue represents the composite, but not the complete electric network.

The impedance for RC-circuits can be considered both for serial, and for parallel connection of their elements. In more complex circuits impedance can be calculated by consecutive, sequential calculations of impedance for small simple parts of circuit, with following using of received results to the following calculations.

Resistance and capacitance in series:  $Z^2 = X_c^2 + R^2$ .



Resistance and capacitance in parallel:  $\frac{1}{Z^2} = \frac{1}{X_c^2} + \frac{1}{R^2}$ .

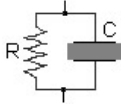

### Electric conductivity of cells and tissues. Equivalent circuitry of the living tissue

The equivalent circuitry of a living tissue is the conditional model approximately describing a living tissue, as a conductor of alternating current.

If as model of a living tissue to take multicellular medium, than at drawing up of the equivalent circuit it is necessary to take into account pathes of electric current.

Their two: around of a cell, in extracellular medium and through a cell. The path around of a cell is submitted only by environmental resistance  $R_{env}$ .

A path through a cell resistance of contents of cell  $R_c$ , and also resistance and in capacity of membrane  $R_m, C_m$ .

The circuit allows considering: what electrical elements the tissue as these elements as properties of a tissue will vary at change of current frequency.

In a circuit basis three positions lay: the extracellular medium and cell contents are ionic conductors with the active environmental resistance  $R_{env}$  and cells  $R_c$ , the cellular membrane is a dielectric, but not ideal, and with a small ion conductance, and, hence, and membrane resistance  $R_m$ , the extracellular medium and the cell contents separate by a membrane, are condensers of  $C_m$  of fixed capacity (0,1 - 3,0 mkF/sm<sup>2</sup>).

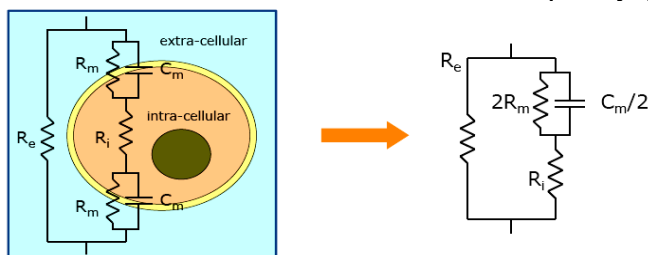

### Electric conductivity of cells and tissues for the direct current

At direct current transmission through living tissues it established, that the current intensity does not remain to constant in time though the put voltage does not variate.

The current intensity after superposition of potential difference starts to be decreased continuously and after a while is positioned on a fixed level.

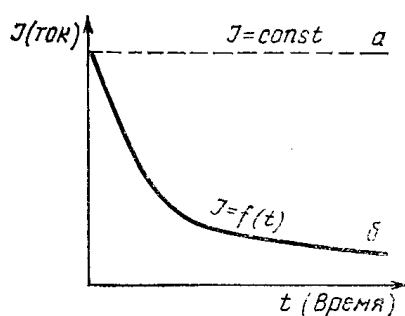

Thus it decreases in hundreds and even thousand times in comparison with a reference value.

Change of a current ( $J$ ) in time ( $t$ ) at superposition on a tissue of a stationary value of potential difference.  $a$  - value of a current at absence of polarization;  $b$  - value of a current at presence of polarization.

At transit of a direct current through biological system in it arises electromotive force of an opposite direction increasing up to some limes (polarizations electromotive force), which reduces enclosed to object efficient electromotive force, as results in decrease of a current. Electromotive force of polarizations  $P(t)$  is function of time. Then the Ohm's law for biological object should be written down:

$$I = (U - P(t)) / R.$$

Originating of electromotive force of polarization is connected to ability of living cells to accumulate charges at current transit through them, i.e. with the capacitive, dielectric properties of biological objects caused by phenomenon of polarization.

More the complete information on biological object can be received at measuring its electric conductivity on an alternating current, therefore now studying of electrical properties of biological systems is routinely effected on an alternating current.

As biological systems are capable to accumulate electric charges at transit through them of a current their electrical properties need to be featured with the help of ohmic resistance. It is necessary to use also concept of electric capacity.

The capacity is quotient of proportionality between a charge and potential and is defined as the attitude of change of charge  $\Delta q$  of a conductor to change of its potential  $\Delta\phi$ :  $C = \Delta Q / \Delta\phi$ .

For a parallel-plate capacitor it is defined under the formula:  $C = \epsilon S / 4\pi d$ , where  $S$  - the area of plates;  $d$  - distance between them.

The measured capacity of biological object is defined by polarization capacity which arises at the moment of transit of a current. The polarization capacity reflects the attitude of change of a charge of object to change of its potential at transit alternating-current.

The considerable on quantity a direct membranes capacitance joins to polarization capacity of biological object. Quantity of polarization capacity depends on time of activity of a field and can exceed on low frequencies quantity of a direct capacitance.

On higher frequencies (about 10 kHz) the direct capacitance on some orders is higher polarization. And as these capacities paired serially, on high frequencies general quantity of capacity is determined smaller on quantity in polarization capacity.

Electric model of biological object can be submitted as various combinations of capacities and resistances – as various equivalent circuits. The most prime are equivalent circuits with serial and a connection in parallel  $C$  and  $R$ .

As biological objects have both conduction, and capacity they will be characterized as the active resistance, and reactance. Reactive capacitive reactance  $R_x$  is determined under the formula:  $R = 1 / \omega C$ ,

where  $\omega$  - circular frequency of a current.

Integral resistance of objects is termed as impedance. For a series connection of  $C$  and  $R$  the impedance is determined under the formula:

$$Z = R - i/\omega C.$$

For parallel - under the formula:  $1/Z = 1/R - i\omega C$ , where  $Z$  - impedance;  $i$  - imaginary unity, i.e.  $\sqrt{-1}$ .

Frequency-dependent character of a capacitive reactance is one of the causes of dependence of an impedance of biological objects from current frequency, i.e. a *dispersion of impedance*.

Dielectric properties of biological objects and quantity of inductivity are defined by structural builders and phenomenon of polarization.

### **Dispersion of impedance**

If time, during which the electric field is guided to one side, is more than relaxation time of any type of polarization, that polarization achieves the maximal value, and the substance will be characterized to certain constant values by efficient inductivity and conduction values. Until the half-period of alternating-current is more than relaxation time, efficient inductivity and conduction of object will not variate with change of frequency.

If at frequency augmentation the half-period alternating-current becomes less relaxation time, that polarization has not time to achieve maximal value. After that inductivity starts to be decreased with frequency, and conduction - to grow.

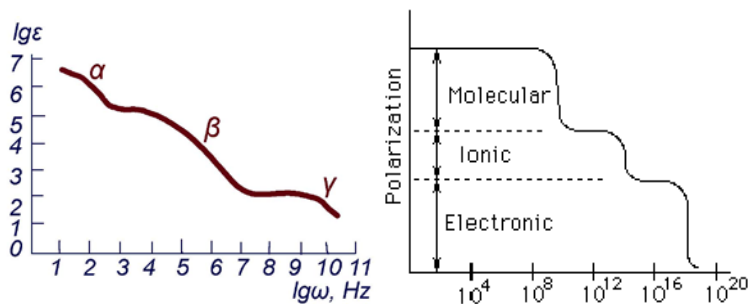

Fig. A dielectric dispersion of a muscle tissue.

**$\alpha$ -Dispersion** occupies range of low frequencies of a sound diapason, approximately up to 1 kHz. In the given range decrease of biological systems inductivity is caused only by decrease of polarization effect of a cells surface as the electric current with frequency up to 1 kHz runs practically only on intercellular interspaces as cells resistance for currents of low frequency is great. Both homogeneous, and the particles surrounded with membranes find out identical properties on the given frequencies.  $\alpha$ -Dispersion has been obtained for glass particles, polystyrene spheres and fatty particles, suspended in electrolyte and having by a double electrical layer. It convincingly shows, that the apparent dispersion is caused by properties of all particle surface.

**$\beta$ -Dispersion** occupies wider range of frequencies:  $10^3$ - $10^7$  Hz. In past for an explanation of a dielectric dispersion and resistance in the given range of frequencies there frequently reverted to the theory of dipole polarization. According to this theory, large molecules of organic substances (proteins, nucleic acids, etc.) have electrical dipole moments of major quantity. Orientation of dipole molecules under activity of an electric field causes major values of inductivity in the given range of frequencies. At augmentation of frequency of a current dipoles have not time to turn after a field that results in decrease of  $\epsilon$ . At high frequency dipole polarization will not be observed absolutely and inductivity again becomes stable.

**$\gamma$ -Dispersion** of tissues inductivity (dielectric permittivity) is observed on frequencies above 1000 MHz. Decrease of inductivity in the given gamut is caused by weakening of effect of polarization, which produced by water dipoles.

Quantity of  $\gamma$ -dispersions will depend on free water content in explored tissues. In range of 400 MHz (between  $\beta$ - and  $\gamma$ -dispersion)  $\epsilon$  quantity for tissues (except for fatty, osteal and cerebral) lays in limits 40-60 in dependence on the free water content.

In range of superhigh frequencies (it is more than  $10^{10}$  Hz) effect of polarization caused by dipoles of water, will miss. Inductivity will have small values determined by ionic and electron polarization, having smallest relaxation time.

## POLARIZATION

Substances have free and bound charges. Free charges (electrons and ions) under activity of electric field have an opportunity to move from one electrode to another, forming a current of conduction. It is necessary to note, that in cells free ions can move under activity of a field in restricted volumes - from one membrane up to another. Bound charges under activity of a field have an opportunity to move only in the some, frequently very restricted limits. At the movement they form **bias current** (offset current, currents of shift).

Process of travel of bound charges under activity of an electric field and formation thereof electromotive force, directional against an external field, is termed as polarization. Time of originating of dipole polarization is termed **relaxation time**. Polarization by the nature is divided into some types.

**Electron polarization** is a result of electron shells shift in relation to position of nucleus: electron shells by electric field lines, nucleus – in opposite direction. It make neutral atom dipole.

As a result of such shift the atom or an ion turns in induced electrical dipole with a direction, counter to an external field.

Time of originating of electron polarization after instantaneous (momentary) superposition of the field, termed as a *relaxation time*, is equaled  $10^{-16}$ - $10^{-14}$  s.

Incipient electrical dipole moment has small quantity.

**Ionic polarization** - shift of an ion concerning a crystal lattice. Thereof there is an electrical dipole moment with a direction, counter to an external field. A relaxation time of ionic polarization  $10^{-14}$ - $10^{-12}$  s.

**Dipole (orientation) polarization.** If the substance contains polar molecules and these molecules are free, under activity of an external field they are oriented according to this field.

Dipole polarization has great importance in substances which molecules have major electrical dipole moment (in water, spirits). Molecules of proteins and also other high-molecular compounds owing to a dissociation of ionizable group, and also owing to adsorption of ions have the considerable electrical dipole moments. The relaxation time variates in limens from  $10^{-13}$  s up to  $10^{-7}$  s.

Time of originating of dipole polarization (relaxation time) coincides in due course rotational displacement a molecules. The relaxation time of polar molecules  $\tau$  depends on viscosity of medium  $\eta$ , temperature  $T$ , radius of molecules  $r$  and is calculated approximately on a Stokes formula:

$$\tau = 4\pi \frac{\eta r^3}{kT}$$

where  $k$  – is Boltzmann's constant.

**Macrostructural polarization** arises under action of electric field owing to a heterogeneity of electrical properties of substances For its originating presence of layers with various an electrical conduction is necessary.

Under activity of a field loose ions and electrons, keeping in conductive substances, move in limits of each incorporation up to border of conducting layer. The further travel of free charges is impossible owing to low conduction with adjacent layers.

As a result of this process conductive incorporation gets electrical dipole moment and behaves similarly to huge polarized molecule.

The relaxation time of macrostructural polarization lays in limens  $10^{-8}$ - $10^{-3}$  s.

Biological objects represent heterogenic structures. Heterogeneity of tissues in a major degree is caused by presence of membranes. To them carry cellular surface membranes and membranes, surrounding cellular organoids and forming a cytoplasmic reticulum. If proper cell cytoplasm has small resistance because of presence in it of a plenty of loose ions membranes have very major resistance ( $1000 \text{ Ohm}/\text{sm}^2$ ) as a result of their small permeability for ions. Macrostructural polarization occurs in all volume of cells, and not just on a cellular membrane as considered earlier as structure heterogeneity is present in all volume of cells. Due to macrostructural polarization which plays the basic role in biological objects, inductivity of tissues, measured in a constant electric field, achieves very major quantities - up to several millions.

The surface polarization occurs on surface, having a double electrical layer.

Double electrical layer is a result of heterogeneous system tendency to diminution of a surface energy that produces an orientation of polar molecules and ions in the surface layers therefore adjoining phases get quantity equal charges with opposite signs.

In case of the surface polarization at superimposed an external field there is a redistribution of ions of a diffusive part of a double electrical layer: particles of a dispersed phase are displaced in one side, and ions of a diffusion layer - in another. As result of it particles of a dispersed phase with counterions of a diffusion layer turn in induced dipoles. A relaxation time of the surface polarization places in limens from  $10^{-3}$  s up to 1 s.



Electrolytic polarization arises between the electrodes putted in electrolyte solution, at electric current transmission through them. The relaxation time of electrolytic polarization is measured by quantities about  $10^{-4}$ - $10^2$  s.

All described phenomenon of polarization to some extent are inherent in biological objects.

At superposition of choronomic potential difference in tissues there is counterly directional electric field which considerably reduces an external field and causes high resistivity of tissues to a direct current (about  $10^6$ - $10^7$   $\text{Om}\cdot\text{sm}$ ).

Thus in the beginning there are those types of polarization which have a smaller relaxation time.

All phenomenon of polarization can be described with the help of inductivity of substances. Inductivity  $\epsilon$  characterizes decrease of quantity of an electric field in substances in comparison with quantity of an electric field in empty space.

### **Self-control material:**

#### **B. Questions**

1. Ohm's law.
2. Bridges theory.
3. The Wheatstone bridge.
4. Impedance.
5. Electical properties of biological tissues.
6. Polarisatation in electrostatic field.
7. Alternating current in biological tissues.

### **Literature recommended**

#### **Main sources.**

- Chaliy at all., Biological and medical physics. – A.V. Chaliy et all.– Ed.A.V. Chaliy. – Vinnitsia, Nova Knyha, 2013. – 480 pp.
- Korovina L.D. Biophysics with beginnings of mathematical analysis and statistics. Extended course of lectures. Vol.2. Bases of thermodynamics. Biomembranes. Electricity and magnetism. – Poltava, 2017.– 114 p.

#### **Additional textbook, journals and references:**

- Compendium of Medical Physics, Medical Technology and Biophysics for students, physicians and researchers. Nico A.M. Schellart. – Department of Biomedical Engineering and Physics Academic Medical Center University of Amsterdam.– Amsterdam.– 2009 (electronic book).

**Methodical elaboration have prepared by senior lecturer, PhD biol.Sc. Korovina L.D.**